

环保物料

Reference Informations:

\*Material: Pin: Brass/Tin-plated

Wafer: Nylon 66, UL94V-0

Dimensional Information:

Part No.	Dimensions	
	A	B
2P	2.00	6.00
3P	4.00	8.00
4P	6.00	10.00
5P	8.00	12.00
6P	10.00	14.00
7P	12.00	16.00
8P	14.00	18.00
9P	16.00	20.00
10P	18.00	22.00
11P	20.00	24.00
12P	22.00	26.00
13P	24.00	28.00
14P	26.00	30.00
15P	28.00	32.00
16P	30.00	34.00
17P	32.00	36.00
18P	34.00	38.00
19P	36.00	40.00
20P	38.00	42.00

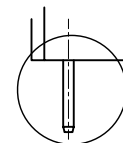
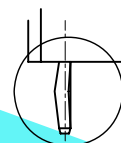
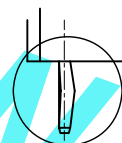
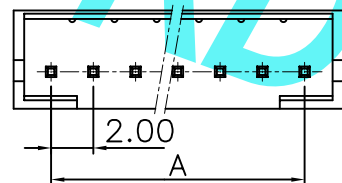

TYPE 1

TYPE 2

TYPE 3

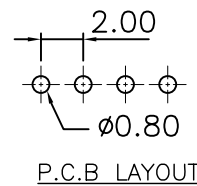
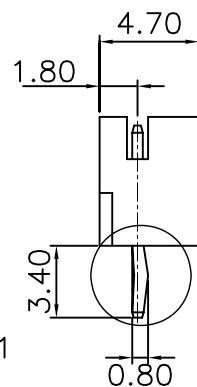
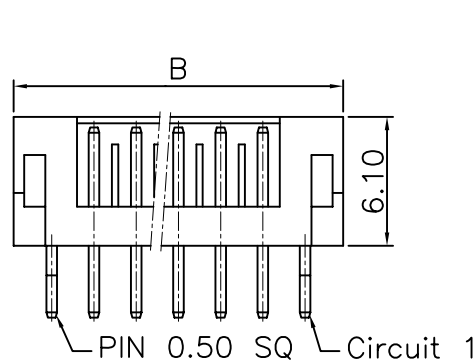

Unit: mm

GENERAL TOLERANCES		SCALE:	NAME	DATE	东莞市康导新能源科技有限公司 DONGGUAN KD NEW ENERGY TECHNOLOGY CO., LTD 公司网址: www.dgkonne.cn 公司电话: 0769-85337633 邮箱: 2860175988@qq.com 公司传真: 0769-85392827	PART. NO.:		
LINEAR	ANGLES	1:1	APPROVED			22004W00-NP*-A1-**		
0.0±0.25	X° REF±6°	DESIGNER				DWG. NO.:		
0.00±0.15	X° ±3°	DRAWN	肖丽娟	2018.07.28		ENDE05		
REV.	REVISION RECORD	DATE	SIZE: A4	0.000±0.08	X° X'±2°	TITLE:	REV: A0	SHEET: 1/1

2.00mm pitch Single Wafer